

# KA107

Amplifier, Low Noise  
1.3 – 3.0 GHz

Preliminary



## DESCRIPTION

The KA107 is a GaAs pHEMT broadband Low Noise Amplifier with high linearity in a hermetic Surface-Mount Technology (SMT) package for high reliability applications. This Amplifier offers excellent gain, Low noise and high linearity from 1.3 to 3.0 GHz. It can be supplied and tested to the screening requirements of MIL-PRF-38535 Class B and S in addition to the required QCI.

## FEATURES

- ✓ High Gain: 20 dB typical @ 1.5 GHz.
- ✓ Low Noise Figure: 0.8 dB typical @ 1.5 GHz.
- ✓ High OP1dB: +22 dBm typical.
- ✓ NASA EEE-INST-002 compliant.
- ✓ High Reliability Class B and S Screening Available.
- ✓ See Page 5 for MFR HI –REL Ordering Details.

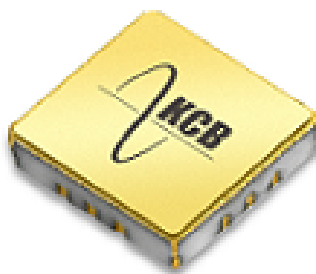

## APPLICATIONS

- ✓ PA Driver
- ✓ Cascaded Gain Block
- ✓ GPS Transceivers
- ✓ IF Amplifier

## ELECTRICAL CHARACTERISTICS (-40 to 95°C)<sup>1</sup>

Parameter	Symbol	Conditions	Min	Typical	Max	Units
Gain	S21	1.3 – 2.0 GHz		20		dB
		2.0 – 3.0 GHz		17		dB
Return Loss (I/O)	S11 / S22	1.3 – 2.0 GHz		10		dB
Supply Current	I <sub>DD</sub>	VDD = 5V		65		mA

1. All electrical characteristics are measured at +25°C at a minimum.

## OPERATING CHARACTERISTICS (-40 TO +95°C)<sup>1</sup>

Parameter	Symbol	Conditions	Min	Typical	Max	Units
Output Compression Point	OP1dB	1.3 – 3.0 GHz	+20	+22		dBm
3rd order output intercept point (+/- 1% spacing)	OIP3	1.3 – 3.0 GHz		+38		dBm
Noise Figure	NF	1.3 – 3.0 GHz			1.5	dB

1. All operating characteristics are guaranteed over full performance temperature range but not tested.

# KA107 | Amplifier, Low Noise 1.3 – 3.0 GHz

TYPICAL PERFORMANCE (+25 °C)

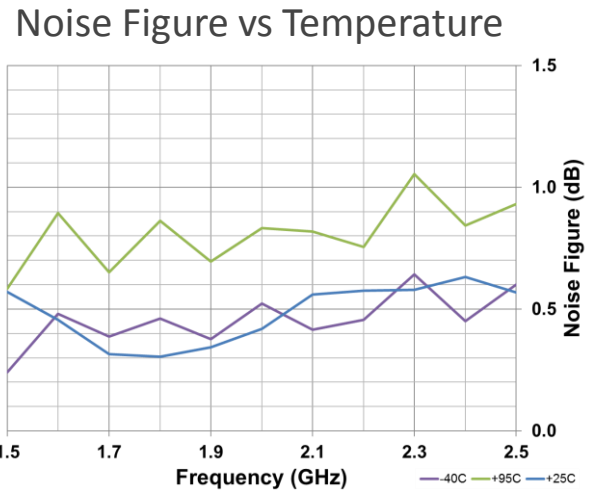
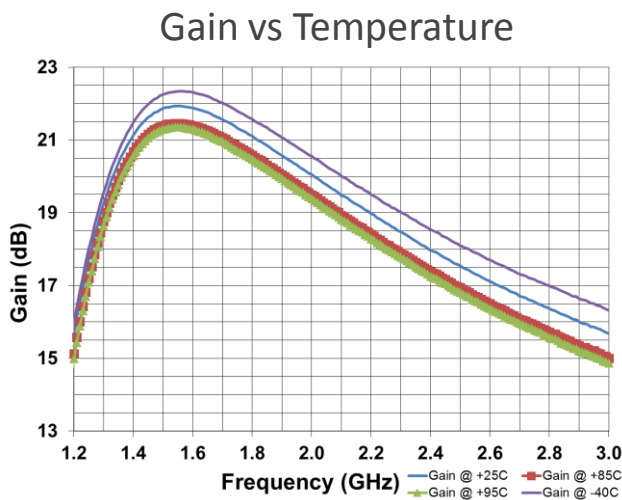
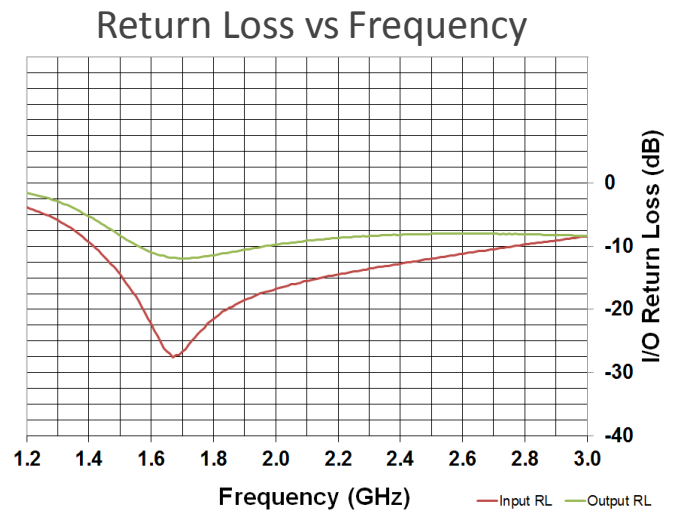
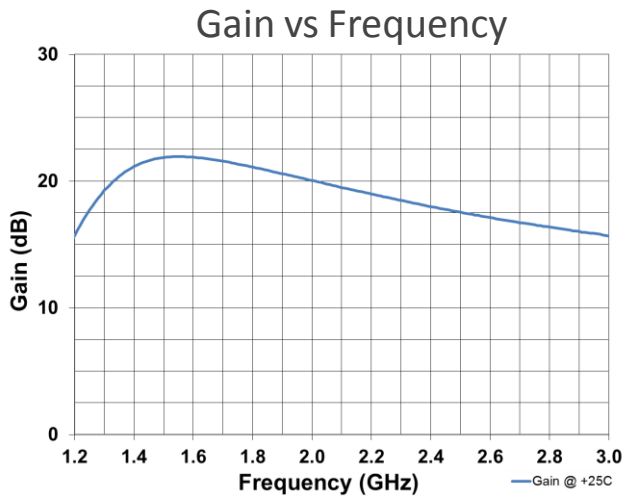

## ABSOLUTE MAXIMUM RATINGS

Characteristic	Min.	Max.	Units
Supply voltage		6.0	V
RF Input power		+20	dBm
Operating temperature	-40	+95	°C
Storage temperature	-65	150	°C
Channel temperature (MTTF > 170 Hrs)		170	°C
Dissipated Power		500	mW
Thermal resistance		60	°C/W
ESD sensitivity (HBM)	500 (Class 1)		V

1. Unit shall survive operation without damage over the temperature range but not tested.



# KA107 | Amplifier, Low Noise 1.3 – 3.0 GHz

## APPLICATION SCHEMATIC

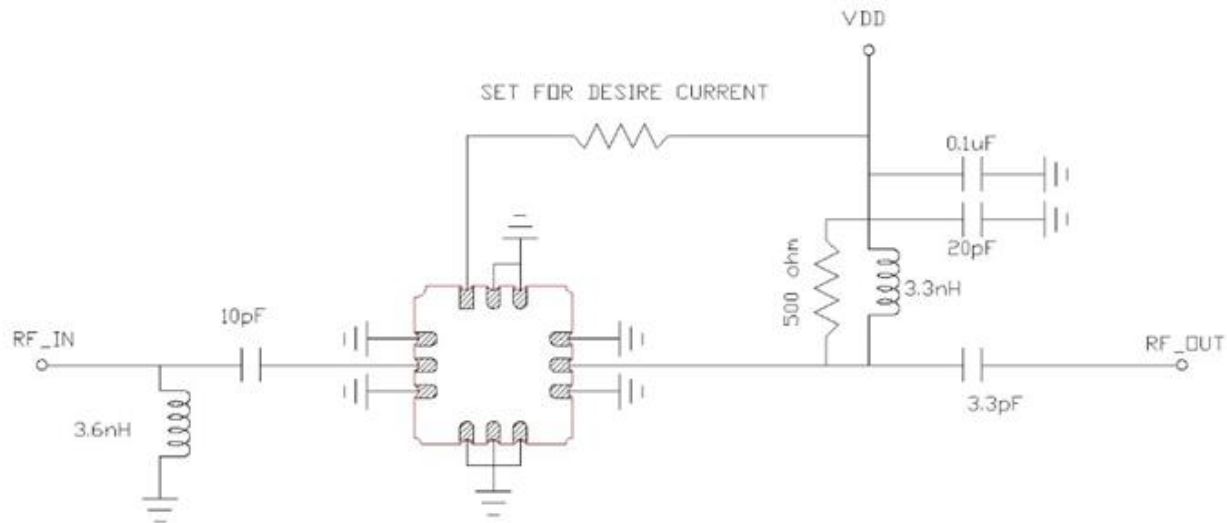

## DEVICE MARKING/PIN OUT:

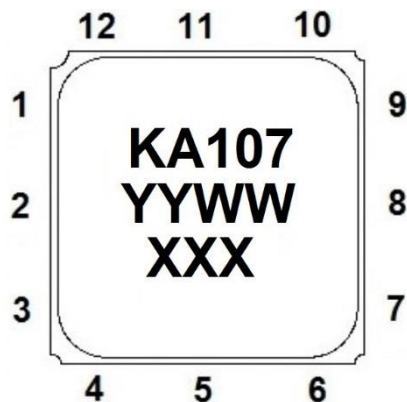

PIN	Designation	PIN	Designation
1	GND	7	GND
2	RF IN	8	RF OUT/ $V_{DD}$
3	GND	9	GND
4	GND	10	GND
5	GND	11	GND
6	GND	12	$V_{SEL}$

## PACKAGE/MARKING NOTES:

- Lid: ASTM F-15 Alloy
- Base/Walls: Alumina
- Lid/Bottom Finish: Gold over Nickel
- YYWW: Lot Date Code
- XXX: Serial number (added for class B and S devices only)

## ADDITIONAL NOTES:

- Maximum reflow temperature: 265°C
- Package base is RF ground
- External blocking capacitors required on all RF ports



# KA107 | Amplifier, Low Noise 1.3 – 3.0 GHz

## OUTLINE:

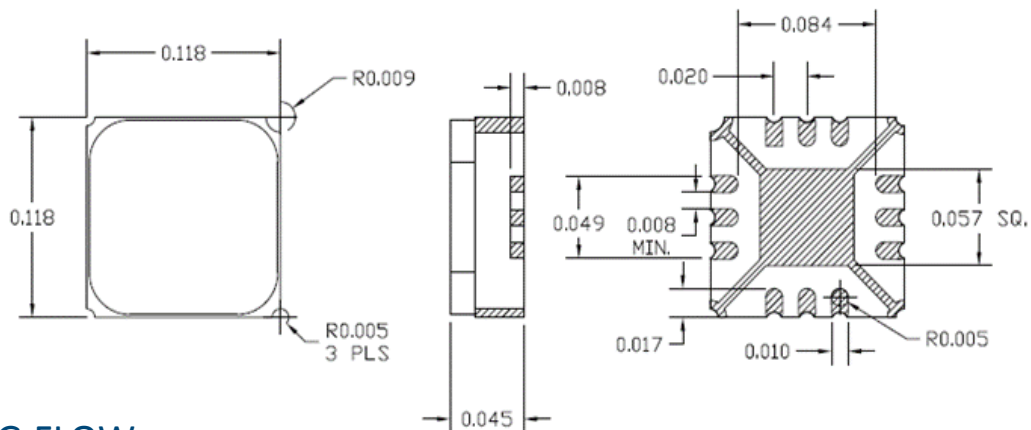

## SCREENING FLOW:

Test Inspection	MIL – STD -883		Requirement	
	Method	Condition	Class B	Class S
Wafer Lot Acceptance /1	5007		N/A	Per Wafer Lot
Non-Destructive Bond Pull	2023		SPC	SPC
Internal Visual	2010	A= Class S, B = Class B	100%	100%
Temperature Cycle	1010	C	100%	100%
Acceleration	2001	E (Y1 only)	100%	100%
PIND	2020	A (5 Cycles)	N/A	100%
Serialization	Per Product Specification		100%	100%
Radiographic	2012	2 views	N/A	100%
Electrical Test	Small Signal Testing	+25OC	100%	100%
Burn In	1015	A	100%/160 Hours/ 125 °C	100%/320 Hours/ 125 °C
Final Electrical	Small Signal Testing	+25OC	100%	100%
PDA Calculation	5004	25% Δ IL / 100% Δ Icc	5%	5%/3% functional
Group A Electrical /5	Per Product Specification	-55OC + 125OC	45/0	45/0
Leak Test	1014 A and C	1 x 10 <sup>-8</sup> Max	100%	100%
External Visual	2009		100%	100%

### Notes:

- Product under configuration control per KCB QAP 015.
- Customer will be notified of all class 1 changes for Class B and S part numbers.
- Wafer Lot Acceptance will include 100% die visual, SEM analysis and Lot Traceability.
- Electrical Test Data will be recorded for each serial number and included in Final Test Report for all Class S part numbers.
- Group A Electrical testing will include the Small Signal at the Min/Max operating condition. The Dynamic test (P1dB, IP3, SS) will be tested at +25c only.

## ORDERING INFORMATION:

	Unscreened	Class H	Class K
KCB Solutions Part Number	KA107C	KA107B	KA107S

