

KS200

Switch, SP4T
0.02–4.0 GHz

DESCRIPTION

The KS200 is a GaAs pHEMT broadband switch with TTL control in a 16-lead hermetic Surface-Mount Technology (SMT) package for high reliability applications. This switch offers low insertion loss and high isolation with good match in both the insertion loss and isolation states. It can be supplied and tested to the screening requirements of MIL-PRF-38534 Class H and K in addition to the required QCI.

FEATURES

- ✓ Low Insertion Loss: 1.4 dB @ 2 GHz.
- ✓ High Isolation: 42 dB @ 2 GHz.
- ✓ Non-Reflective Match in off state (S22).
- ✓ NASA EEE-INST-002 compliant.
- ✓ High Reliability Class H and K Screening Available.
- ✓ See Page 5 for MR HI –REL Ordering Details.

APPLICATIONS

- ✓ Microwave Radios
- ✓ Military Radios
- ✓ VSAT
- ✓ Telecom Infrastructure
- ✓ Test Equipment

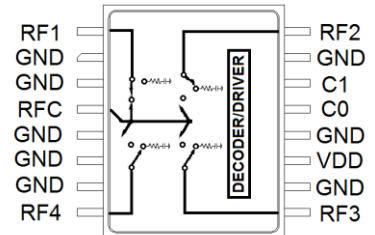
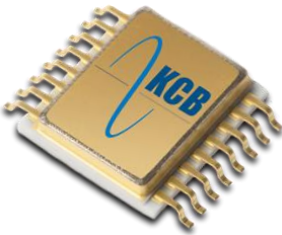
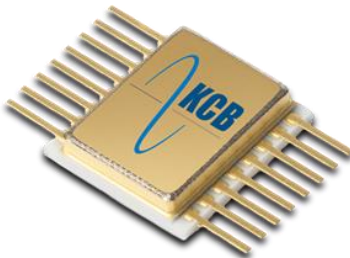

ELECTRICAL CHARACTERISTICS (-40 to 85°C)¹

Parameter	Symbol	Conditions	Min	Typical	Max	Units
Insertion Loss	IL	0.02 – 1.0 GHz		1.2	1.6	dB
		1.0 – 2.0 GHz		1.4	1.8	dB
		2.0 – 3.2 GHz		1.5	2.0	dB
		3.2 – 4.0 GHz		2.0	2.5	dB
Isolation	ISO	0.02 – 1.0 GHz	43	48		dB
		1.0 – 2.0 GHz	37	42		dB
		2.0 – 3.2 GHz	35	39		dB
		3.2 – 4.0 GHz	30	33		dB
Return Loss Input (All States) Output (ON State)	S11 / S22	0.02 – 1.0 GHz	14	18		dB
		1.0 – 3.2 GHz	12	15		dB
		3.2 – 4.0 GHz	8	10		dB
Return Loss Output (OFF State)	S22	0.30 – 0.7 GHz	5	8		dB
		0.7 – 3.2 GHz	12	15		dB
		3.2 – 4.0 GHz	10	12		dB

1. All electrical characteristics are measured at +25°C at a minimum.

OPERATING CHARACTERISTICS (-40 TO +85°C)¹

Parameter	Symbol	Conditions	Min	Typical	Max	Units
Input Compression Point	IP1dB	0.02 – 0.3 GHz	+13	+24		dBm
		0.3 – 4.0 GHz	+20	+30		dBm
3rd order input intercept point (+7 dBm tones, 1 MHz spacing)	IIP3	0.02 – 0.1 GHz	+22	+35		dBm
		0.1 – 4.0 GHz	+30	+45		dBm
2nd order input intercept point (+7 dBm tones, 1 MHz spacing)	IIP2	0.02 – 0.1 GHz	+28	+65		dBm
		0.1 – 4.0 GHz	+43	+70		dBm
Rise/Fall Time	t _{RISE} /t _{FALL}	10% RF rise/fall time		40	100	nS
ON/OFF Time	t _{ON} /t _{OFF}	50% V _{CTL} to 90%/10% RF		125	200	nS
Control Voltage High	V _{IH}	V _{DD} = 4.5 – 5.5 V	2.0		V _{DD} +0.5	V
Control Voltage Low	V _{IL}	V _{DD} = 4.5 – 5.5 V	-0.5		0.8	V
Digital Input Leakage	I _{IN}	V _{DD} = 4.5 – 5.5 V	-1		1	μA
Supply Current	I _{DD}	V _{DD} = 4.5 – 5.5 V			2	mA

1. All operating characteristics are guaranteed over full performance temperature range but not tested.

ABSOLUTE MAXIMUM RATINGS

Characteristic	Min.	Max.	Units
Supply voltage	-0.3	7.0	V
Control voltage	-0.5	V _{DD} + 0.5	V
RF Input power		+32	dBm
Operating temperature	-40	+85	°C
Storage temperature	-65	150	°C
Thermal resistance		400	°C/W
ESD sensitivity (HBM)		200 (Class 0)	V

1. Unit shall survive operation without damage over the temperature range but not tested.

TYPICAL PERFORMANCE (+25 °C)

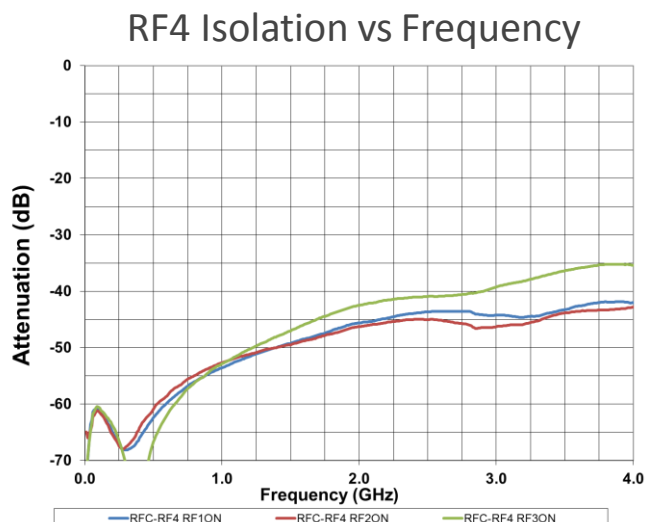
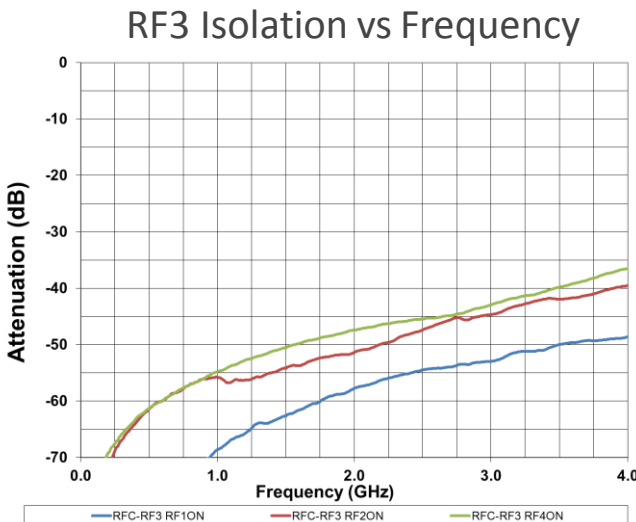
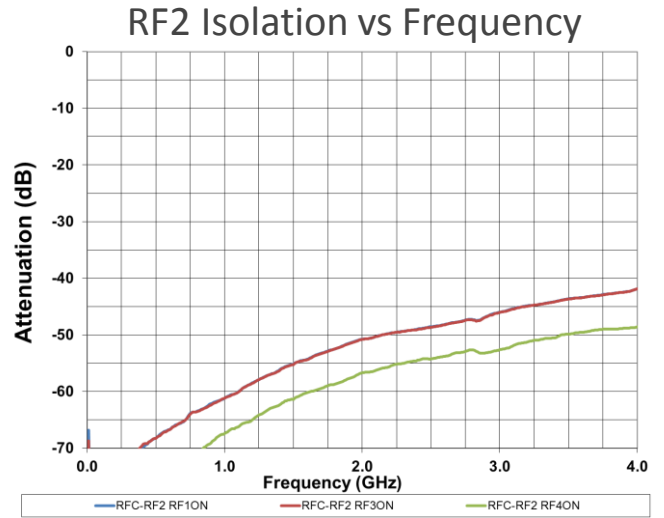
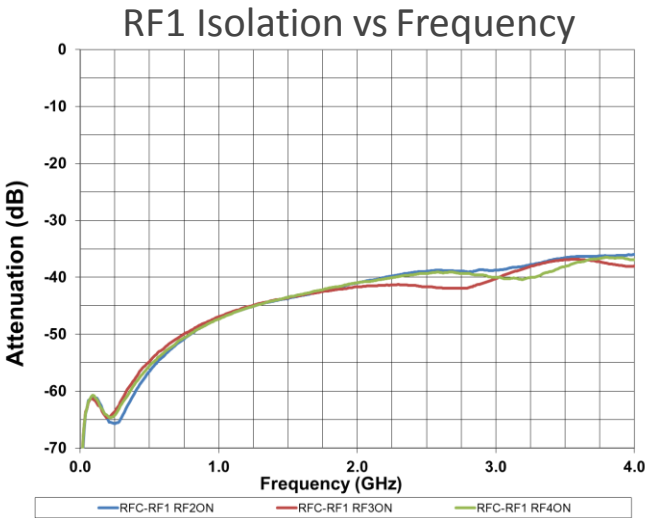
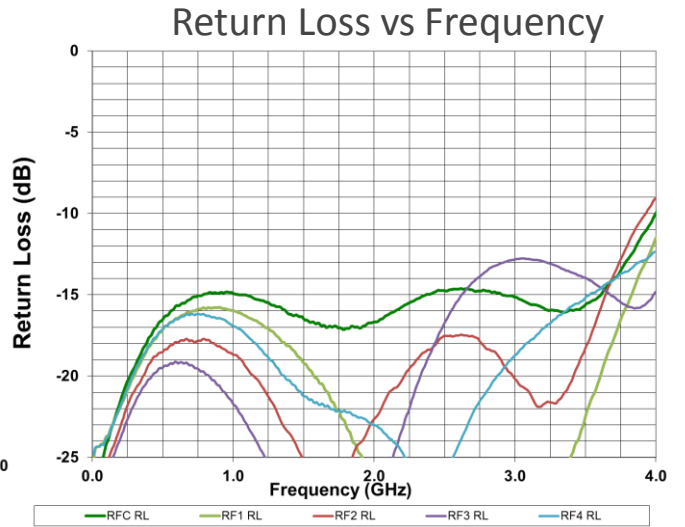
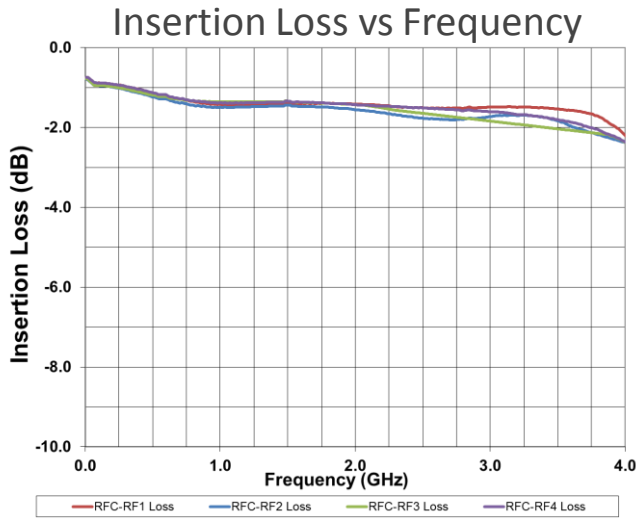

KS200 | Switch, SP4T

TRUTH TABLE

C0	C1	RF Path
1	1	RF1—RF4
0	1	RF1—RF2
1	0	RF3—RF4
0	0	RF3—RF2

SCHEMATIC

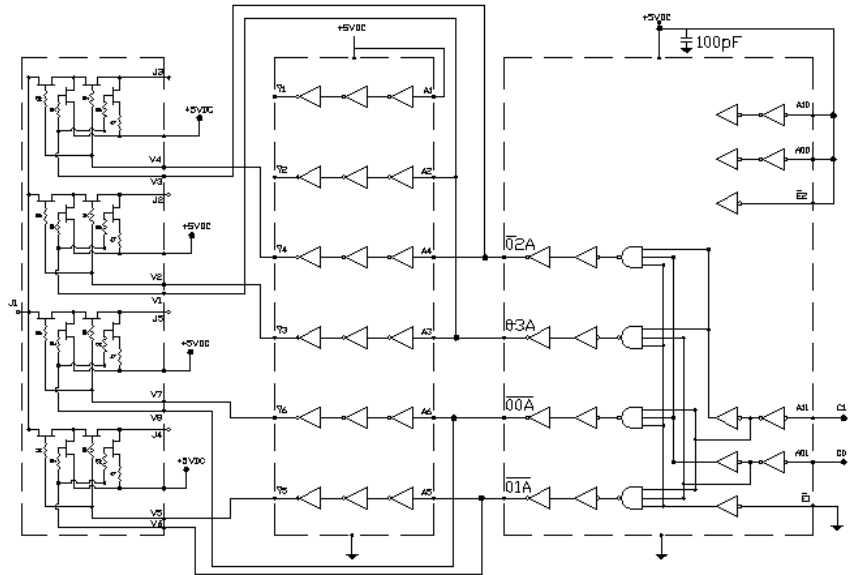

DEVICE MARKING/PIN OUT:

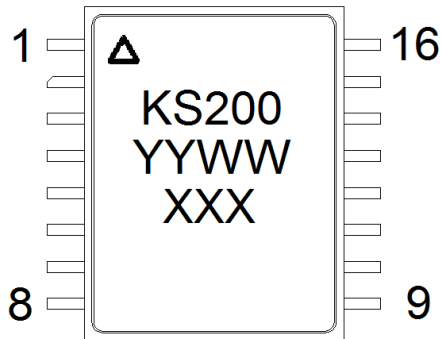

PIN	Designation	PIN	Designation
1	RF1	9	RF3
2	GND	10	GND
3	GND	11	V _{DD}
4	RFC	12	GND
5	GND	13	C0
6	GND	14	C1
7	GND	15	GND
8	RF4	16	RF2

PACKAGE NOTES:

- Lid/Leads: ASTM F-15 Alloy
- Base/Walls: Alumina
- Lid Finish: Gold over Nickel
- Leads/Seal Ring/Bottom: Gold over Nickel

ADDITIONAL NOTES:

- Maximum reflow temperature: 265°C
- Package base is RF ground
- External blocking capacitors required on all RF ports

KS200 | Switch, SP4T

OUTLINE:

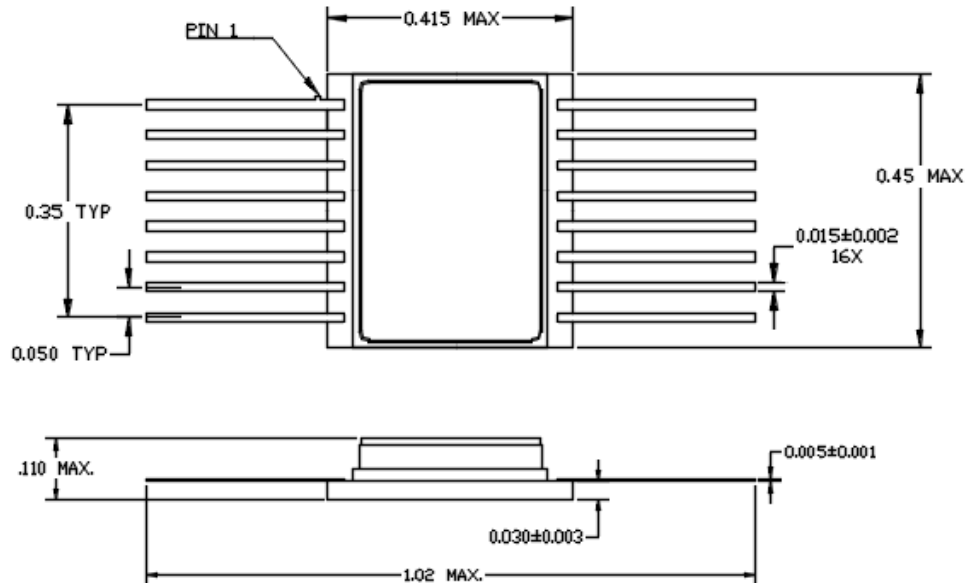

SCREENING FLOW:

Test Inspection	MIL – STD -883		Requirement	
	Method	Condition	Class H	Class K
Element Evaluation	MIL-PRF-38534	Table C-1	Per Table	Per Table
Non-Destructive Bond Pull	2023		Process under SPC	100%
Internal Visual	2010	A = Class H, B = Class K	100%	100%
Temperature Cycle	1010	C, 10 Cycles	100%	100%
Acceleration	2001	B (Y1 only)	100%	100%
PIND	2020	A (5 Cycles)	N/A	100%
Serialization	Per Product Specification		100%	100%
Radiographic	2012		N/A	100%
Electrical Test	Per Product Specification	+25OC	100%	100%
Burn In	1015	A	100%/160 Hrs/125OC	100%/320 Hrs/125OC
Final Electrical	Per Product Specification	+25OC	100%	100%
Group A Electrical	Per Product Specification	-40OC and + 85OC	45/0	45/0
Seal: Fine Leak		A		
Gross Leak	1014	C	100%	100%
External Visual	2009		100%	100%

Notes:

1. Product under configuration control per KCB QAP 015.
2. Customer will be notified of all class 1 changes for Class H and K part numbers.
4. Electrical Test Data will be recorded for each serial number and included in Final Test Report for all Class K part numbers.
5. Group A Electrical testing will include the Small Signal at the Min/Max operating condition. The Dynamic test (P1dB, IP3, SS) will be tested at +25c only.

ORDERING INFORMATION:

	Unscreened	Class H	Class K
KCB Solutions Part Number	KS200C	KS200H	KS200K

